



File No.:E75887



File No.:R 50194653



FEATURES

- 4000VAC high dielectric strength between contacts and coil is available
- Max. switch capacity up to 40A

CONTACT RATINGS

Contact Arrangement	1A, 1B, 1C
Contact Resistance	50mΩ (1A 24VDC)
Contact Material	Silver Alloy
Contact Rating(Resistive)	30/40A 277VAC 30A/28VDC
Max. Switching Voltage	277VAC/28VDC
Max. Switching Current	40A
Max. Switching Power	11080VA/840W
Mechanical Life	1×10 ⁷ operations
Electrical Life	5×10 ⁴ operations

ORDERING INFORMATION

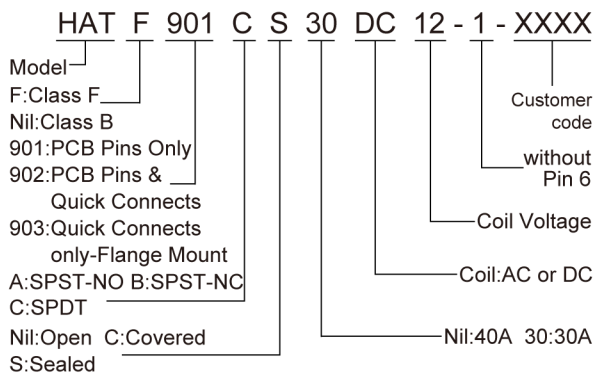

Note: 1) HAT902&903 relays do not have pin 6.

2) HAT902&903 series: The "S" is defined as sealed without leaking test. If leaking test is necessary, please specify and contact with our sales.

CHARACTERISTICS

Insulation Resistance	1000MΩ (at 500VDC)	
Dielectric Strength	Between coil & contacts	2000VAC 1min
	Between open contacts	1500VAC 1min
Operate time (at nomi. volt.)	≤15ms	
Release time (at nomi. volt.)	≤10ms	
Humidity	98% RH, 40°C	
Ambient temperature	Class B: -40°C~85°C Class F: -40°C~105°C	
Shock Resistance	Functional	98m/s ²
	Destructive	980m/s ²
Vibration resistance	10Hz to 55Hz 1.5mm DA	
Unit weight	Approx. 36g	
Construction	Sealed, Covered, Open type	

Notes: 1) The data shown above are initial values.

2) Please find coil temperature curve in the characteristic curved below.

COIL DATA

at 25°C

DC

Nominal Voltage VDC	Pick-up Voltage (Max.) VDC	Drop-out Voltage (Min.) VDC	Max. Allowable Voltage VDC	Coil Resistance Ω±10%
5	3.75	0.50	6.50	27
6	4.50	0.60	7.80	40
9	6.75	0.90	11.70	97
12	9.00	1.20	15.60	155
15	11.25	1.50	19.50	256
18	13.50	1.80	23.40	380
22	16.50	2.20	28.60	640
24	18.00	2.40	31.20	660
48	36.00	4.80	62.40	2560
110	82.50	11.00	143.00	13400

This datasheet is for customers' reference. All the specifications are subject to change without notice.



RELAYS

* SINCE 1976 *

TEL:(516) 328-9292 FAX:(516)326-9125 www.hascorelays.com email:info@hascorelays.com

AC

Nominal Voltage VAC	Pick-up Voltage (Max.) VAC	Drop-out Voltage (Min.) VAC	Max. Allowable Voltage VAC	Coil Resistance $\Omega \pm 10\%$
12	9.6	1.2	14.40	27
24	19.2	2.4	28.80	120
110	88.0	11.0	132.0	2360
120	96.0	12.0	144.0	3040
220	176.0	22.0	264.0	13490
240	192.0	24.0	288.0	15735
277	221.6	27.7	332.4	20300

COIL

Coil Power	DC:900mW AC:2VA
------------	-----------------

SAFETY APPROVAL RATINGS

UL&CUL	NO	1HP/120VAC, 2HP/277VAC, 2HP/240VAC 20A/277VAC Ballast, 30A/120VAC Ballast 40A/277VAC Resistive Load *
	NC	1HP/120VAC, 2HP/277VAC 10A/277VAC Ballast, 2A/120VAC Tungsten 40A/277VAC Resistive Load *
TüV	40/240VAC(NO), 40/240VAC(NC) 6×10^3 operations* 20A/240VAC/14VDC, 15A/240VAC/14VDC	

* Note: If you need this rating, please contact our company.
For the additional ratings, please contact our company.

OUTLINE DIMENSIONS, WIRING DIAGRAM AND PC BOARD LAYOUT.

Unit: inch(mm)

Outline Dimensions

Wiring Diagram (Bottom view)

PCB Layout (Bottom view)

with Pin 6	HAT 901 Series			
	HAT 901 Series Open Type			
	HAT 901 Series without Pin 6		 (1B, 1C See next page)	

This datasheet is for customers' reference. All the specifications are subject to change without notice.

OUTLINE DIMENSIONS, WIRING DIAGRAM AND PC BOARD LAYOUT.

Unit: inch(mm)

Outline Dimensions

Wiring Diagram (Bottom view)

PCB Layout (Bottom view)

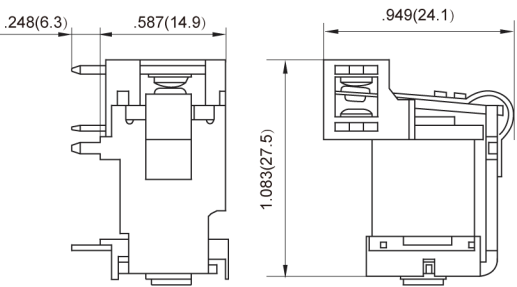
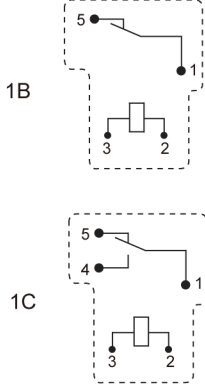
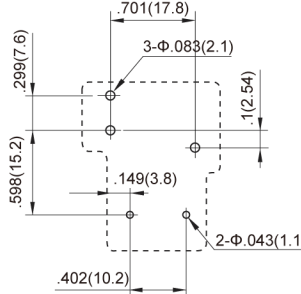
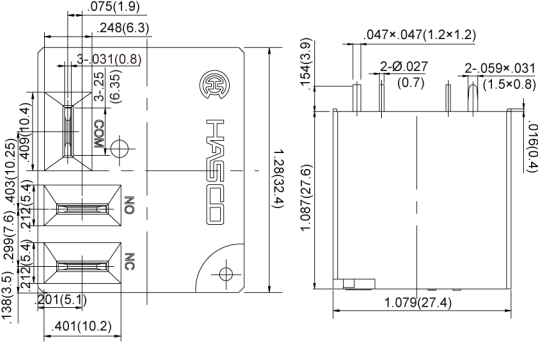
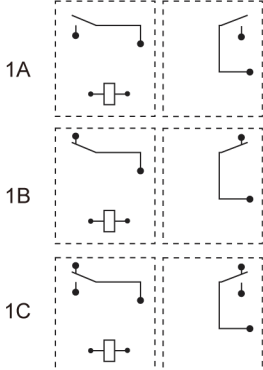
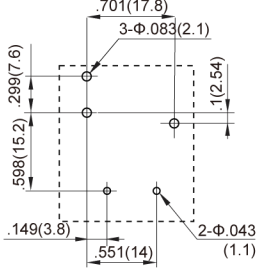
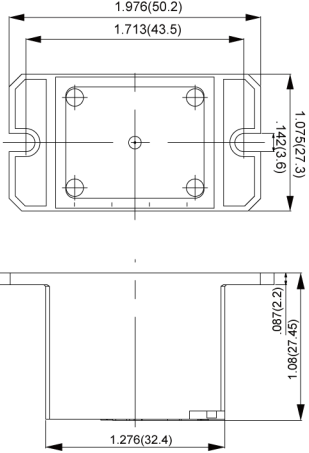
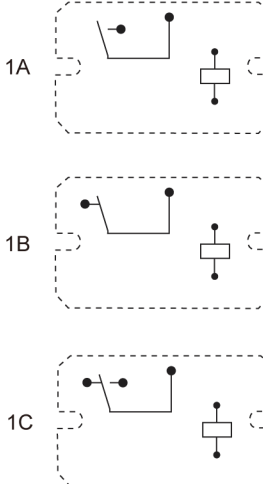
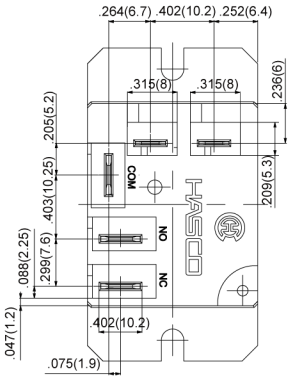
<p>HAT 901 Series Open Type without Pin 6</p>			
<p>HAT 902 Series</p>			
<p>HAT 903 Series</p>			

Remark: 1) In case of no tolerance shown in outline dimension: outline dimension $\leq 1\text{mm}$, tolerance should be $\pm 0.2\text{mm}$; outline dimension $> 1\text{mm}$ and $\leq 5\text{mm}$, tolerance should be $\pm 0.3\text{mm}$; outline dimension $> 5\text{mm}$, tolerance should be $\pm 0.4\text{mm}$.

2) The tolerance without indicating for PCB layout is always $\pm 0.1\text{mm}$.

This datasheet is for customers' reference. All the specifications are subject to change without notice.

CHARACTERISTIC CURVES

MAXIMUM SWITCHING POWER

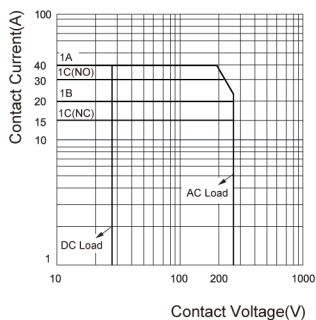

ENDURANCE CURVE

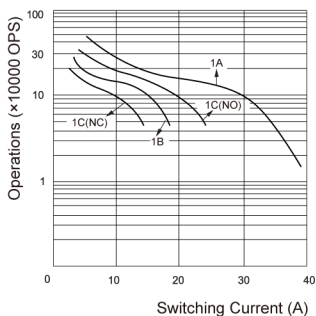

COIL TEMPERATURE RISE

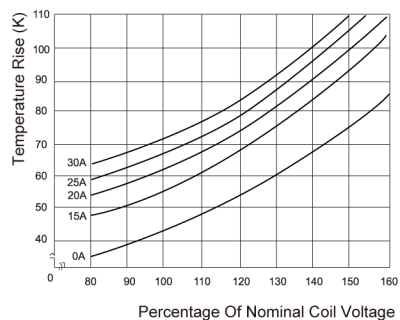

OPERATE TIME / RELEASE TIME

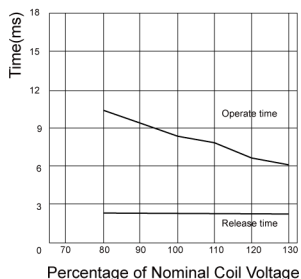

This datasheet is for customers' reference. All the specifications are subject to change without notice.